

INSTRUCTION 10.09

FAST POP

**THIS INSTRUCTION BASED ON K-10,
APPLIED INTO K-10A, K-10B, K-10C, K-10D, K-10DB**

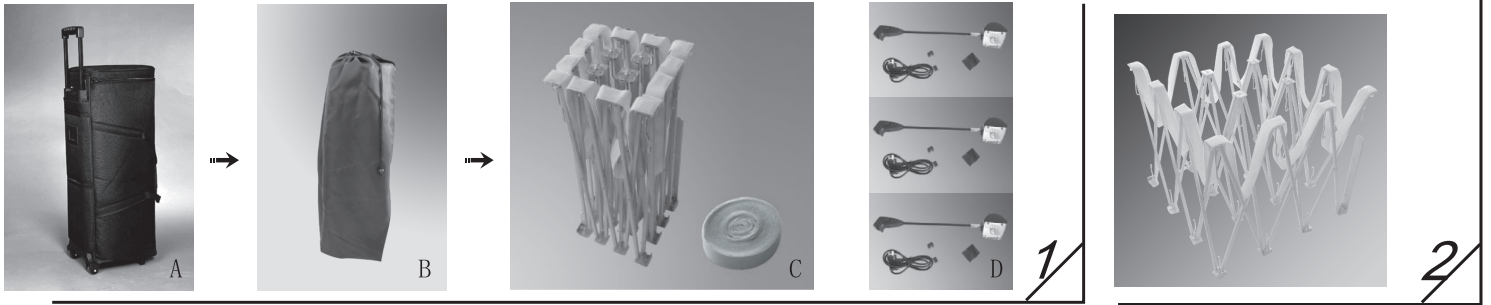

1. The soft case contains frame and accessories, 3 lamps are available as optional accessories.

2. Draw the frame as the pic showing. ps: An assistant is necessary.

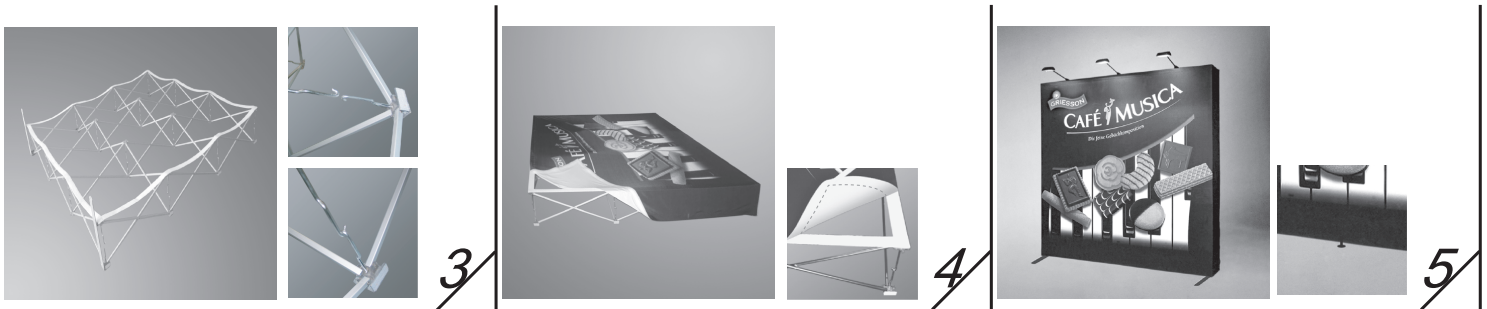

3. Draw it completely and make the metal hooks join together.

4. Stick the fabric onto the installed frame by velcro.

5. The unit can be levelled by adjusting the threaded feet at the bottom of the base unit.

THE FOLLOWING ACCOUNT FOR FABRIC GRAPHIC

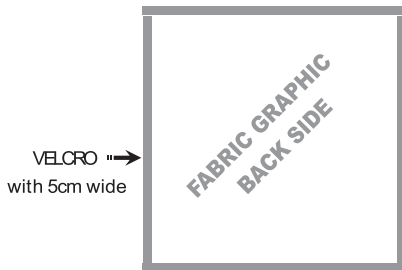

THE FOLLOWING ACCOUNT FOR K-10C FRAME

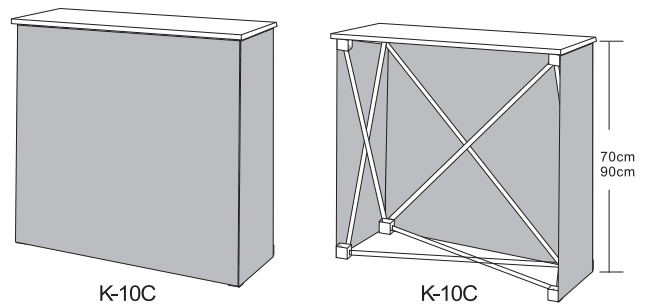

K-10D



Connection

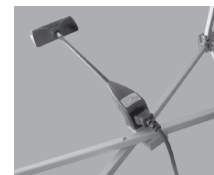

Lamp



Corner



Adjustable feet

K-10B

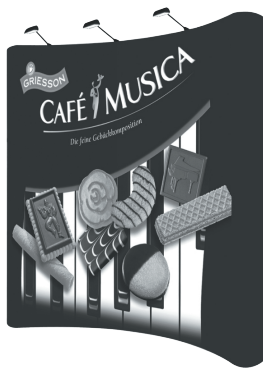

Frame

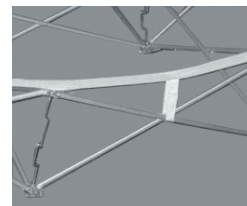

Connection

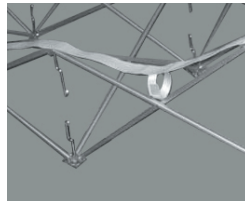

Connection

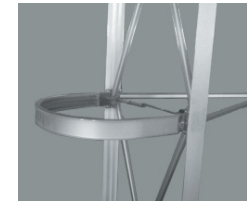

Corner

Optional accessories



YC-11-X1



YC-11-X2



YC-11-X4



HYB.L.-1008

POP UP skeleton map

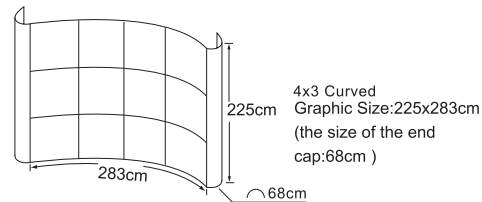
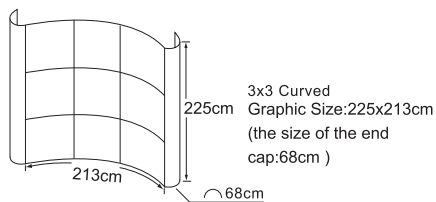
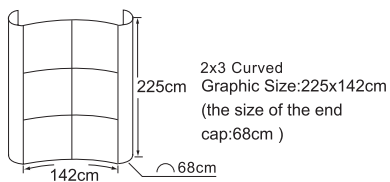
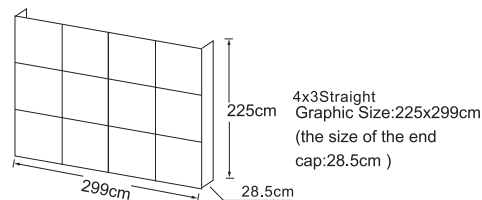
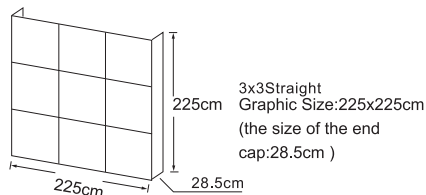
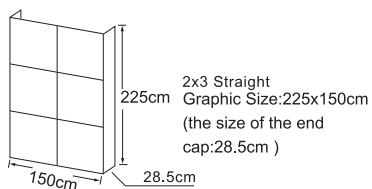

SPECIFICATIONS

Model	Type	Graphic Size	Net Weight	Package	Gross Weight	Outer Carton Size	Measurement	Color
K-10	3x3straight	225x225cm	13.2kg	1pcs	15.8kg	38x43x90cm	0.147m ³	SL
K-10A	3x3straight	283x225cm	13.2kg	1pcs	15.8kg	38x43x90cm	0.147m ³	SL
K-10B	3x3curved	350x225cm	22.0kg	1pcs	25.0kg	42x45x102cm	0.193m ³	SL
K-10C	90cm	147x88.5cm	6.5kg	1pcs	8.0kg	20x25x96cm	0.048m ³	SL
	70cm	130x68.5cm	4.5kg	1pcs	6.0kg	20x25x86cm	0.043m ³	SL

Our products keep upgrading. Rights to change parts reserved.